

- **Versatile:** Perfect for deep sea operations or deck-mounted planned production cutting
- **Dependable:** Designed to cut the toughest wire rope
- **Easy to use:** Open mouth design simplifies ROV deployment
- **Durable:** Engineered to last in the harshest of environments
- **Reliable:** Proven Webtool technology gives cutting edge performance
- **Powerful:** High output force ensures a successful cut
- **Low maintenance:** Long blade life ensures minimal servicing

Contact our engineering team to arrange cut trials or to discuss bespoke designs.
All products are made in the UK.

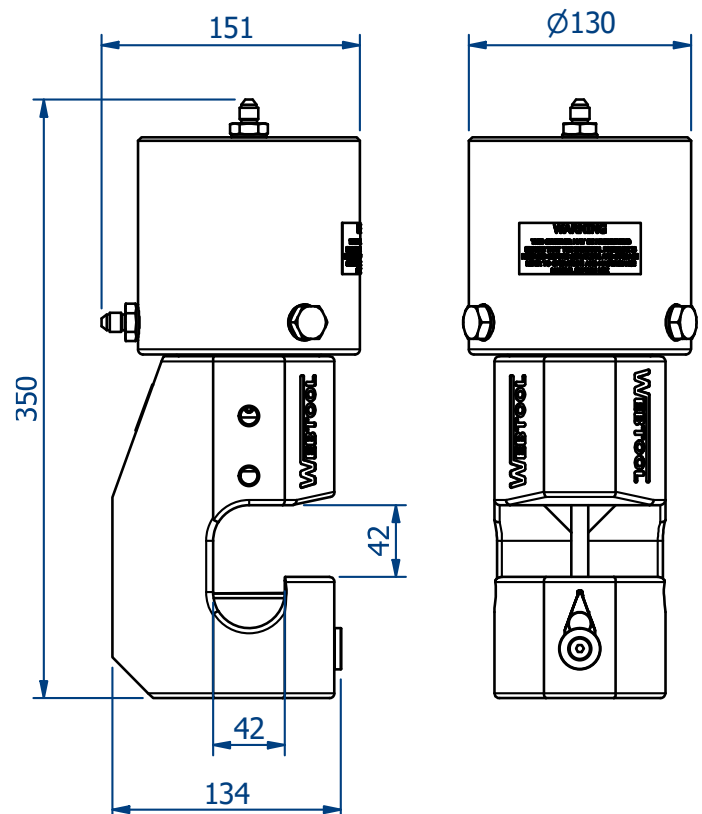

www.allspeeds.co.uk

Webtool – A division of Allspeeds
Royal Works, Atlas Street
Clayton-Le-Moors, Accrington,
Lancashire. BB5 5LW
UK Tel: +44 (0) 1254 615 100
Email: info@allspeeds.co.uk

Technical Specifications

- Maximum Ø40mm cutting capacity
- 220 bar maximum input pressure
- Approx weight in air: 22kg
- Approx weight in water: 19kg
- Swept volume cut stroke: 0.5 litres
- Swept volume return stroke: 0.4 litres

Spare Parts and consumables

- Seal Kit (995121)
- Blade (705032C)
- Anvil (761311)

Additional Extras

HP690A – Hydraulic Intensifier



Hydraulic panel with minibooster intensifier and additional safety circuits that prevent overpressure when returning to the surface. Available in a range of intensification.

HTP – Hydrostatic Test Pump



Hydrostatic test pump complete with tank, skid, handle and pressure gauge. Perfect for testing any hydraulic equipment. Available in a range of pressures up to 1000 bar.

Side Handle – Part No 999023



ISO standard D-handle to suit most ROV's.

Storage Cases



Sturdy cases can be purchased alongside cutters.